

Varenummer: 2310431011S
Beskrivelse: E+G Stilleben
LX.25-SW13-M8X19-S

Mål

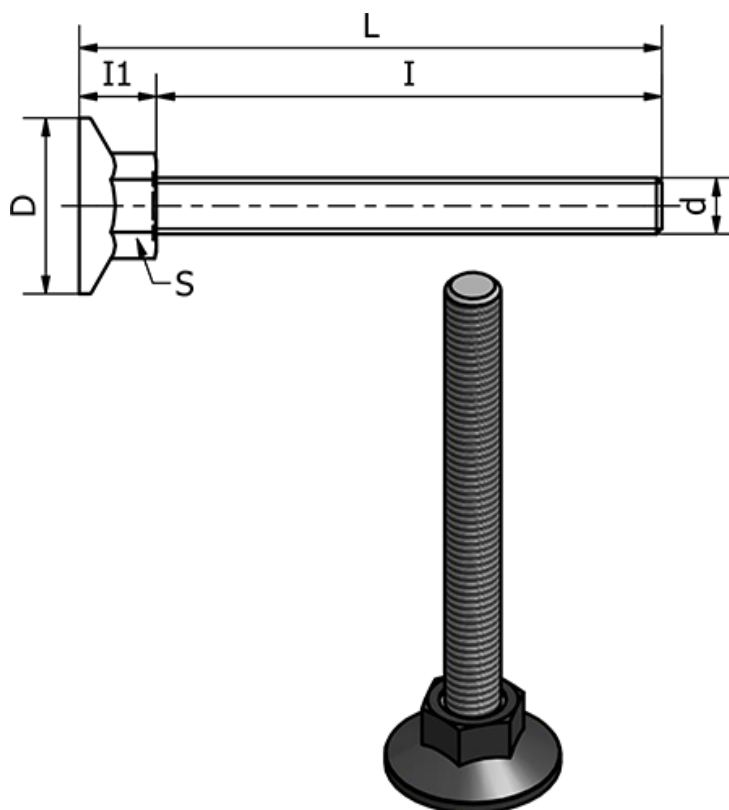

d	= M8
D	= 25
I	= 19
I1	= 11
L	= 30
Max statisk belastning (N)	= 2500
S	= 13
Type	= Forzinket

Vægt (g) = -